

Wall System



GRID
S Y S T E M

grid.ternoscorrevoli.com



GRID

SYSTEM



Imagine ... create

GRiD, the new Terno Scorrevoli Wall System, was created with a precise objective in mind: to redefine the domestic space.



GRID
SYSTEM

TABLE OF CONTENTS

Redefine the space	p. 4
Maximum flexibility	p. 6
A complete system	p. 8
Practicality and elegance	p. 12
Modules for every need	p. 14
Finishes and materials	p. 16
For modern needs	p. 18
Maximum comfort	p. 20
Two rooms in a flash	p. 22
The space you don't expect	p. 24
Culture or relaxation?	p. 26
Fast assembly	p. 28
Rack pole	p. 29
Solution simulation	p. 30
Construction specifications	p. 32
Standard solutions and modules	p. 35
Construction examples	p. 36
Description of measures	p. 38
Accessories	p. 40
GRiD accessories: possible realisations	p. 41
Universal System: handles	p. 45
Pivot Door: covers and finishes	p. 45
Terms of sale	p. 46



Redefine the space

More rational spaces with style and elegance?

From today you can.

Modern needs require innovative solutions that can adapt to increasingly flexible and frequently changing spaces.

Redefining space therefore means not only rationalizing a room, but rethinking it with a view to change. The house is therefore a place that must be able to change accordingly with people's needs.

The walls, movable and modular, were created to adapt to the needs of a modern lifestyle that leaves ample room for creativity and the possibility of dividing each room as you like.

Designing your home space has become easier because as of today, it is also possible to do it post-realization.

An eco-sustainable solution

GRiD is an open system that stems from current needs such as: flexibility, brightness and sustainability.

Made entirely of aluminum, it is combined with a paneling in glass or wood according to the design needs. A great advantage that combines aesthetics and practicality with a nod to the environment.

The GRiD System is at its best when combined with the glass paneling where the larger and brighter spaces make the room more modern, allowing also for a partial energy saving thanks to the natural light that can be exploited for most of the day.



Maximum flexibility thanks to the equipped walls

GRiD SYSTEM, in addition to being a versatile partitioning system, is a real "organizer" of spaces. Thanks to the rack system and the basic modules designed for the most common needs, allowing you the possibility of equipping the walls to your specific liking. With the GRiD System it is easy not only to divide the space, but to obtain complete rooms that can meet all needs. Such as the division between the kitchen and the living room, or creating a walk-in closet inside a bedroom, or even: a study in the corner of the house, a fully-equipped laundry room and everything that the imagination might come up with.

GRiD SYSTEM is also an open system. Designers, architects and builders will be able to create their own modules taking advantage of the infinite possibilities that this structural system offers.



"Not only space and aesthetics, but practicality. Comfortable, useful, practical: equipped walls release the ability to create and reorganize rooms."



Pivot

Hinged system for hinged doors made with Universal frame, telescopic jamb and opening up to 180°.

www.ternoscorrevoli.com/pivot

A complete system

GRID SYSTEM shows another important side of its versatility, thanks to the door systems that can be integrated.

Born as a natural extension of the **Universal System**, today the **Pivot System** offers the opportunity to create either push or pull hinged door closures, both with a **Pivot hinge** for openings up to 180°, and with the **invisible hinges** currently on the market.

A complete system that satisfies any structural and space requirement, always maintaining a minimalist and ethereal essence.



- Opening up to 180°
- Available in 3 different finishes
- Heights studied for a continuity of vision

- Swing or Sliding Closure
- Easy composition and customization
- Modular structure in Kit

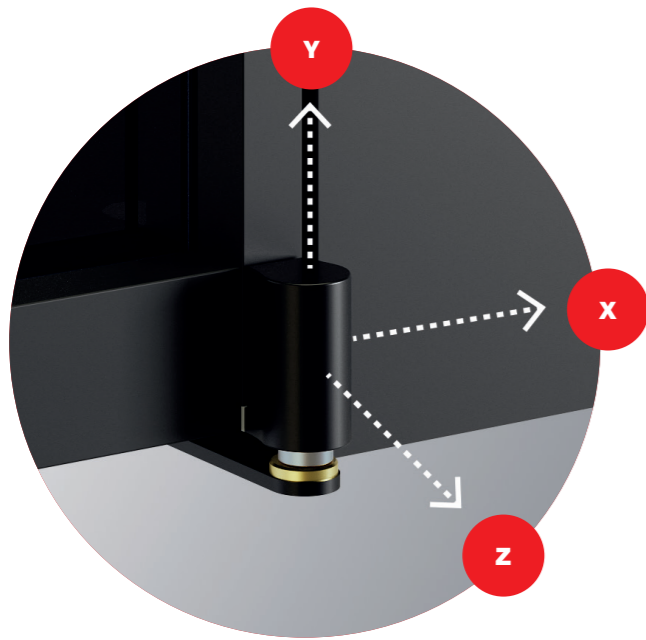

Pivot

S Y S T E M

A practical and elegant system

Pivot, the new system for elegant and flexible hinged doors, has been designed to meet all installation needs. The system has a **hinge with decentralized axis**, for installation on door with **aluminum frame of the Universal series** with glass from 6 to 8 mm, **without requiring work to apply the hinge.**

Hinge with integrated adjustments

- Height adjustment
- Front offset adjustment, to align the door frontally to the frame
- Adjustment of the lateral inclination of the door, to reflect the gap between the door and the doorframe, along the 3 sides of the door (the lower one is excluded)

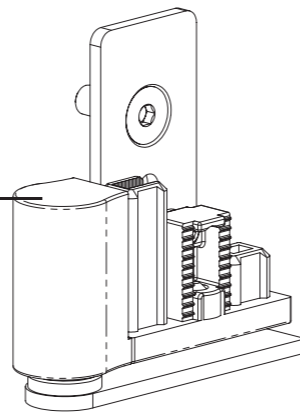

.28 | METAL GREY



.30 | GRAPHITE



.39 | WHITE RAL 9002

Broad flexibility in terms of aesthetic solutions for handles

The Pivot system integrates perfectly with the GRiD System and offers customers the possibility to choose between **three different types of handle:**

1. Magnetic Stricker Handle Cover.
2. Patent key lock cover.
3. Cover with European profile cylinder hole.



Magnetic Stricker Handle Cover

	C.0490.01.01.28	Metal Grey
	C.0490.01.01.30	Graphite
	C.0490.01.01.39	White RAL 9002

Patent Key Lock Cover

	C.0490.01.02.28	Metal Grey
	C.0490.01.02.30	Graphite
	C.0490.01.02.39	White RAL 9002



Cover with European profile cylinder hole

	C.0490.01.03.28	Metal Grey
	C.0490.01.03.30	Graphite
	C.0490.01.03.39	White RAL 9002



Practicality and elegance

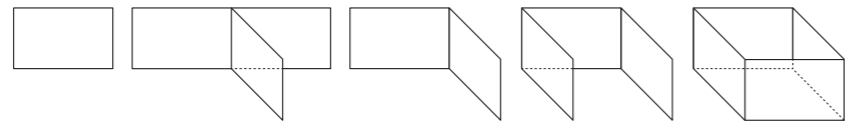

GRID is an extremely practical system and this is evident right from the design stages.

Based on a real program, it offers a complete construction solution, able to transform a semi-finished product into a structural construction base that offers all the necessary construction characteristics, as well as the right compromise between aesthetics and technology.

- **Equipped or Continuous Walls in different materials**
- **Complete and easy to assemble system**
- **Up to 3m in height**
- **Swing or sliding closure**
- **Basic accessories available**
- **Easy customization**

MODULES FOR EVERY NEED

GRiD SYSTEM was born with some modules to its assets that make it a complete solution and ready for a range of different spaces.

The following modules are currently available: clothes hanger, shoe rack, trousers hanger, chest of drawers, shelves, tie-holder.

The system, which is constantly evolving, is the result of technical and practical research that will give rise to produce other modules in the future.

In addition to those on offer, it is also possible to make your own, provided that they comply with the standard construction specifications available in the technical manuals.



FINISHES AND MATERIALS

Practical with style

GRiD SYSTEM is not only practical but adapts with style to the most common aesthetic needs thanks to a minimalist design and **3 standard finishes** that complete the range.



.28 | METAL GREY



.30 | GRAPHITE



.39 | WHITE RAL 9002



Environmentally Friendly

The structure is designed entirely in aluminum, a material that combines: strength, construction flexibility and eco-sustainability, given that it is 98% recyclable.

The structure is then combined with the most common materials such as glass and wood, which make it possible to create modern and minimalist ambients, which are at the same time warm, welcoming and ecological.

"GRiD SYSTEM was created as a reorganization tool, especially at home. A place that in recent years has been significantly reconsidered, in particular with a renewed focus on the liveability of a space. A topic on which the GRiD System is particularly focused."



For modern needs

The use of remote working has grown exponentially in recent years. As a result of recent historical events, experts have assessed that Smart Working is not a simple temporary practice, but a situation destined to last over time. GRiD SYSTEM is the perfect solution in this sense, as it offers organized spaces and equipped walls that can be set up in a few steps and with just a few elements, with everything you need to organize a practical and efficient work corner in any room.

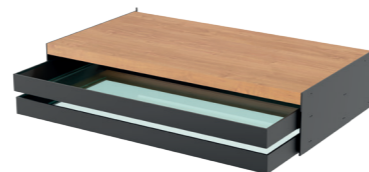



Your personal SPA

Thanks to its flexibility, creating an ideal location and personalizing each space to make it unique, will be simple and practical.

Maximum comfort

How to enhance a space: from one to more rooms in just a few steps.

The GRiD system partition walls are ideal for organizing any area of the house.

The practical installation and the possibility of using the **Pivot** or **Universal** systems at your leisure, offers endless possibilities in terms of constructive and stylish combinations.

In this way, in a few steps, it is possible to create extraordinary spaces by transforming the house into a practical, relaxing and organized place.

Universal

The innovative Terno Scorrevoli frame, made for glass, wood and aluminum doors

www.ternoscorrevoli.com/universal

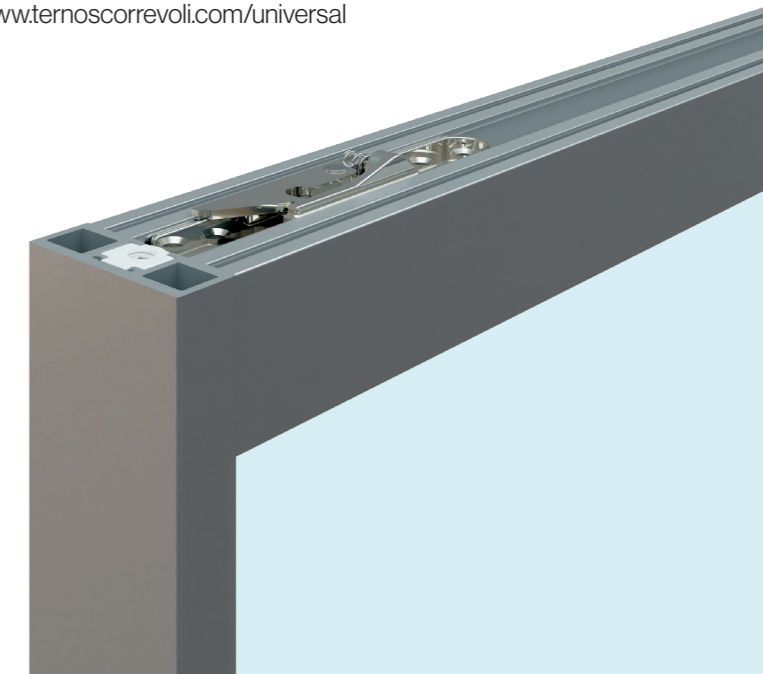



Two rooms in a flash

When division becomes an art form

Customer needs today are not merely extemporaneous needs and often stem from the need to organize a whole life. Needs that over the years change and transform, growing step by step with a smaller or larger family unit.

Reshaping the structure of a room by moving floors, walls, entranceways, doors and windows is a cost and an objective

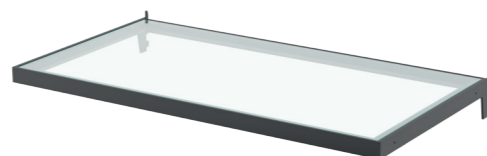

difficulty that forces, whoever plans it, to adapt to all the problems that arise.

Another issue is freedom of choice. Choosing how to organize your space, choosing to be able to divide the rooms if necessary, choosing to do so without necessarily having to resort to construction or structural works, limiting costs and



accelerating construction times is a significant factor for many. GRID SYSTEM is able to offer this freedom. A real advantage that offers extreme simplicity of reorganization and exceptional technical flexibility.

Thus, over the years, configurations can change and adapt perfectly to the needs of a family, without necessarily having to resort to investments.

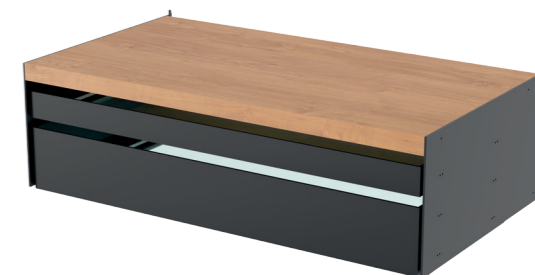

The space you don't expect

For everyday use

Not only is the flexibility of the GRiD System undeniable: what is equally undeniable is that its only limit is user creativity.

A concept that is not surprising if we think that the needs to which it can respond are almost infinite.

Thanks to the basic materials it is also possible to structure

rooms with very specific characteristics, such as a laundry. Rooms that tend to be particularly humid and require a practical optimization of the walls, equipping them with the right modules.

From this point of view, the rack structure offers unparalleled practicality and organizational flexibility, able to better distribute

the spaces and organize shelves according to every need, even extremely customized solutions.

The system is then completely open and allows you to easily adapt any floor space using the rack and pinion bases sold as standard modules.

GRiD SYSTEM: simple and practical for any space.





A proper bookcase

Making a bookcase has never been so simple and practical. The practical installation of the GRiD System allows you to create a bookcase with a modern and lightweight design in just a few steps.

The elegance and lightness of the structure make the GRiD System an aesthetically beautiful and functional piece of furniture.

The practical structure, which is easily installed, allows you to create neat and elegant spaces in just a few steps.

That's how a simple linear structure made of shelves and drawers, combined with a wooden paneling, completes with few modules a modern living room.



Culture or relaxation?

Fast Assembly

Thanks to the **regulators** in the GRiD System structure, the **assembly** and insertion of the glass paneling is **very easy**.



You may access the technical manual and assembly instructions via this link: grid.ternoscorrevoli.com

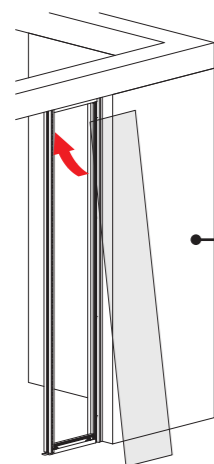
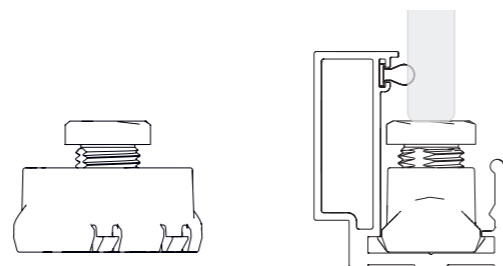

Creation of the first module consisting of: Wall Starting Kit + Fixed Module + Rack Pole

The glass panel is inserted into the upper profile, rests on the regulators, and is then inserted into the profile and, thanks to a simple adjustment, can be easily aligned.

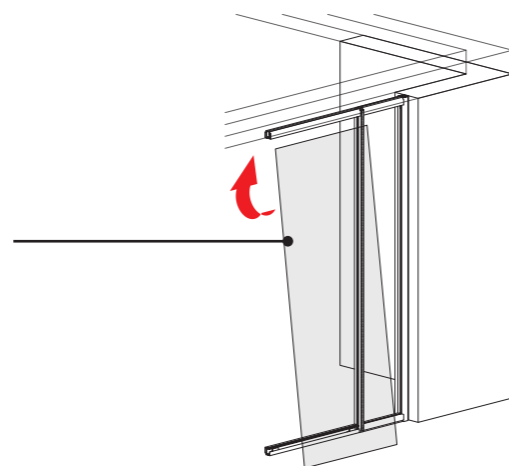

Creation of the next module consisting of: Fixed Module + Rack Pole

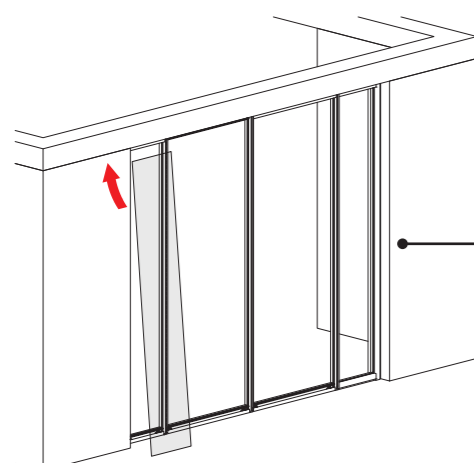

The final module is completed using: Fixed Module + Rack Pole + Fixed Module + Wall Starting Kit

Rack Pole



300cm

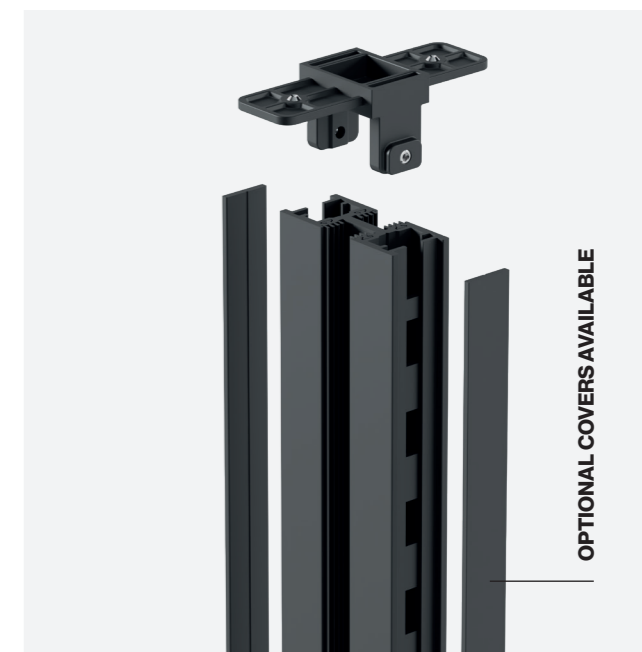

The rack pole has a dual function:

Structural

To support and connect the solutions: wall start, L-shaped, T-shaped, Pivot door and Universal door.

Organizational

To equip the walls with the standard modules marketed by Terno Scorrevoli, designed according to your needs, fully compliant with the construction standards set out in the technical manuals.

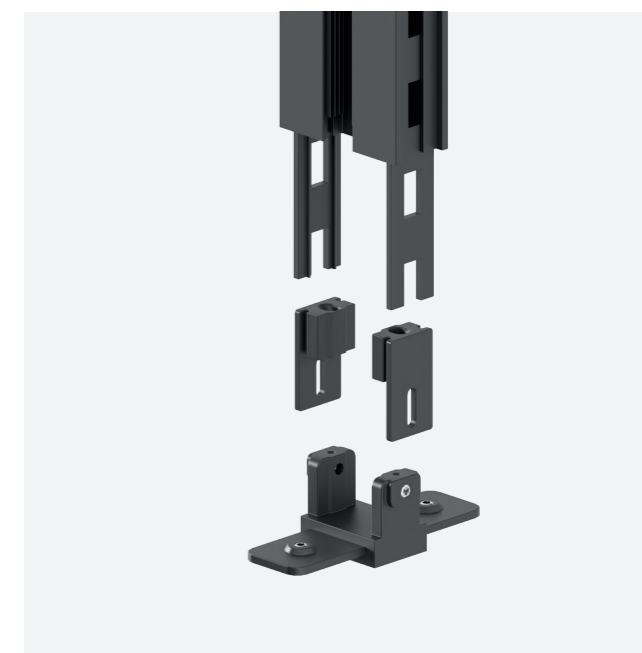

Solution Simulation

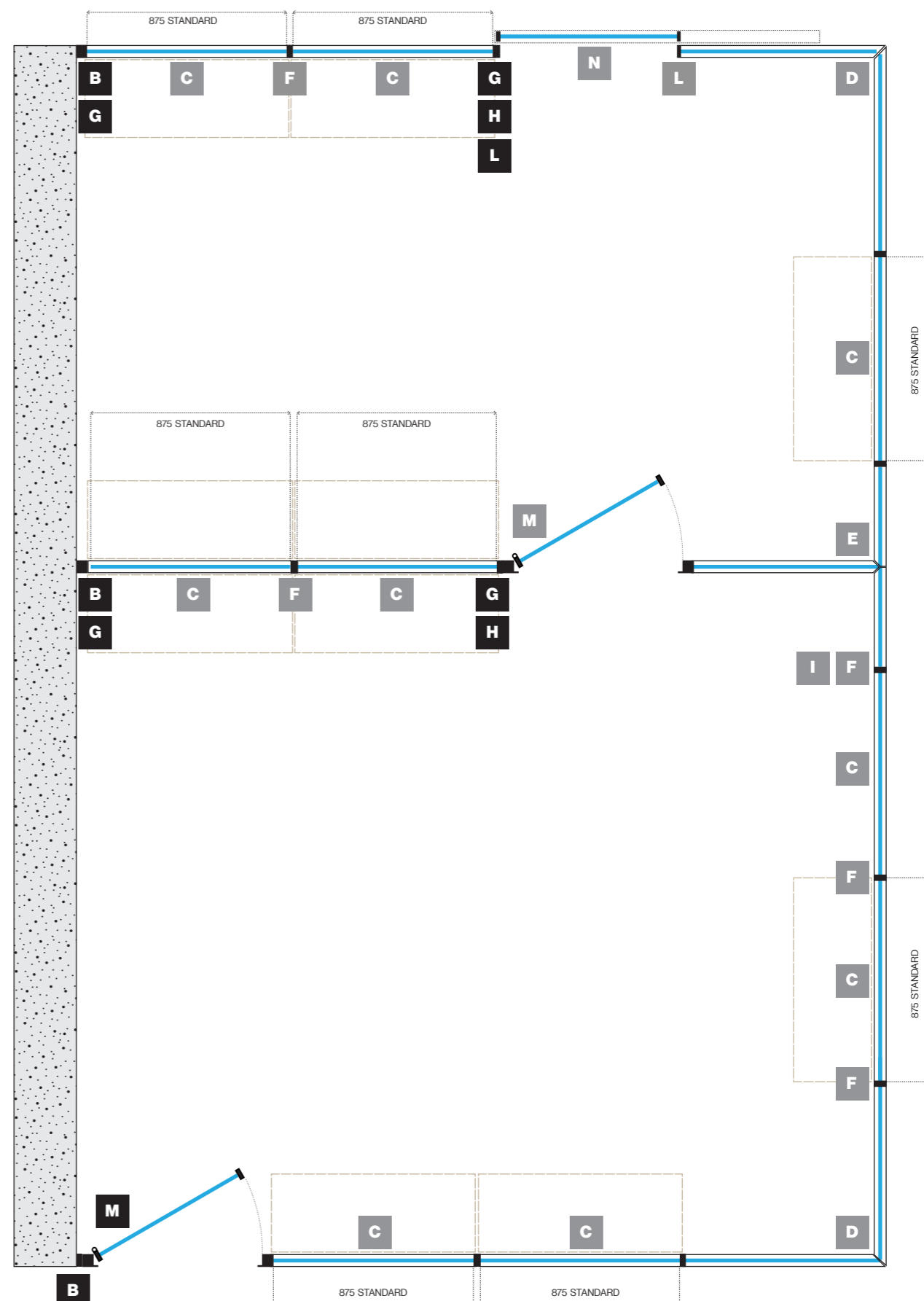
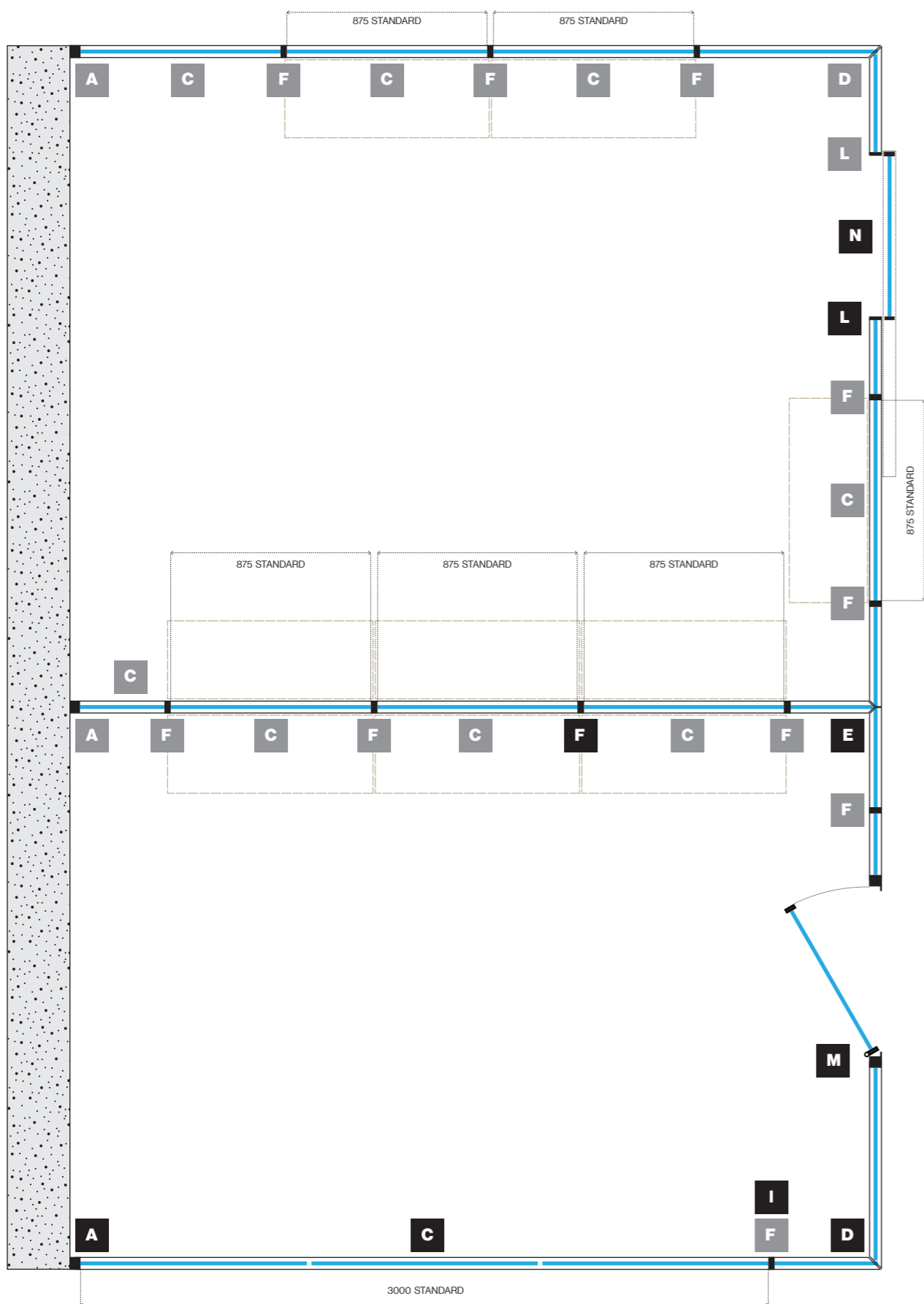

In these examples, we try to imagine the construction of a room, starting from a pre-existing wall and creating two examples of **closed three-sided solution**, entirely realised with the standard kits and accessory modules.







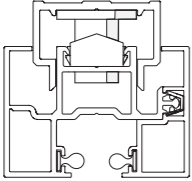
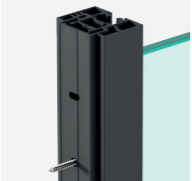
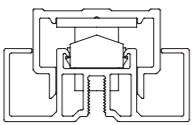

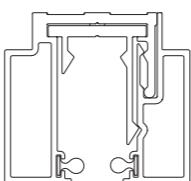
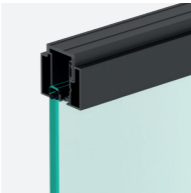
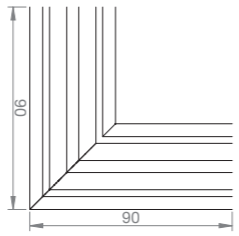

Construction Specifications

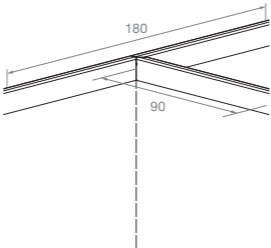

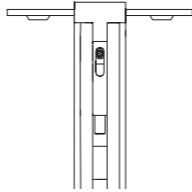

By following the table below and multiplying the objects by the number of parts required, it is possible to create the solution proposed on the next page..

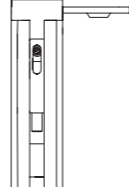



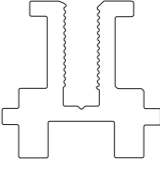

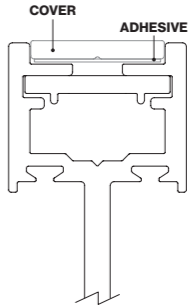
 .28 METAL GREY	 .30 GRAPHITE	 .39 WHITE RAL 9002	FINISHES

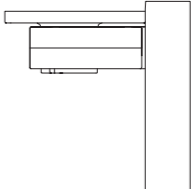
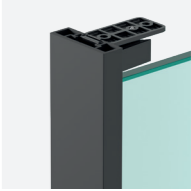
Wall Starting Kit	
Kit Code	Finishes
F.0521.01.00	.28 .30 .39
 	
Equippable Wall Starting Kit	
Kit Code	Finishes
F.0521.07.00	.28 .30 .39
 	

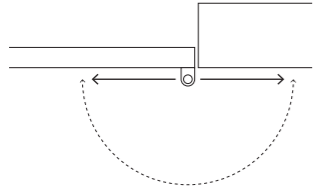
Fixed Module			
	Kit Code	Finishes	
C	F.0520.01.02	3000 Standard	.28 .30 .39
	F.0520.01.00	900 Standard	.28 .30 .39
 			
L-Shaped Module			
	Kit Code	Finishes	
D	F.0520.02.03		.28 .30 .39
			
T-Shaped Module			
	Kit Code	Finishes	
E	F.0520.03.03		.28 .30 .39
			

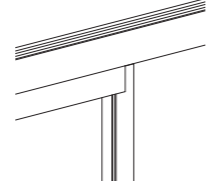
Rack Pole			
	Kit Code	Finishes	
F	F.0521.03.00	Rack pole	.28 .30 .39
	F.0522.00.00	Gasket bundle 10 mm	—
	F.0522.01.00	Gasket bundle 12 mm	—
 			
Equippable Rack Pole			
	Kit Code	Finishes	
G	F.0521.09.00	Equippable rack pole	.28 .30 .39
	F.0522.00.00	Gasket bundle 10 mm	—
	F.0522.01.00	Gasket bundle 12 mm	—
 			

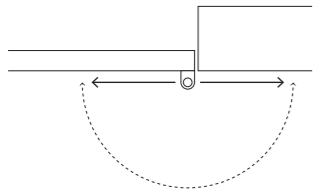
Equippable Junction Pole			
	Kit Code	Finishes	
H	F.0521.08.00	.00 (Raw)	
	 		
Rack Pole Covers			
	Kit Code	Finishes	
I	F.0521.11.00	.28 .30 .39	
	 <p style="color: red; font-weight: bold; text-align: center;">OPTIONAL</p> 		
Terminal Pole			
	Kit Code	Finishes	
L	F.0521.02.00	Terminal pole	.28 .30 .39
	F.0522.00.00	Gasket bundle 10 mm	—
	F.0522.01.00	Gasket bundle 12 mm	—
 			

M		Pivot Door (Magnetic Stricker Arrangement)			N		Universal Door		
		Kit Code		Finishes			Kit Code		Finishes
		F.0520.05.00	Crossbeam	.28 .30 .39			F.0520.04.01	Sliding section	.28 .30 .39
		F.0523.01.00	Pair of poles	.28 .30 .39			K.0423.1.3	Universal Door 1500x3000	.28 .30 .39
		K.0491.01.09	Pivot Door 1000x3000	.28 .30 .39					
									
M		Pivot Door (Handle and Lock Arrangement)							
		Kit Code		Finishes	Shells	Shell Finishes			
		F.0520.05.00	Crossbeam	.28 .30 .39		C.0490.01.02	Lock cover with Patent Key	.28 .30 .39	
		F.0523.01.00	Pair of poles	.28 .30 .39					
		K.0491.02.09	Pivot Door 1000x3000	.28 .30 .39					
					C.0490.01.03	Cover with Euro profile cylinder hole	.28 .30 .39		
					C.0490.01.01	Handle Cover with Magnetic Stricker	.28 .30 .39		

Standard solutions and modules

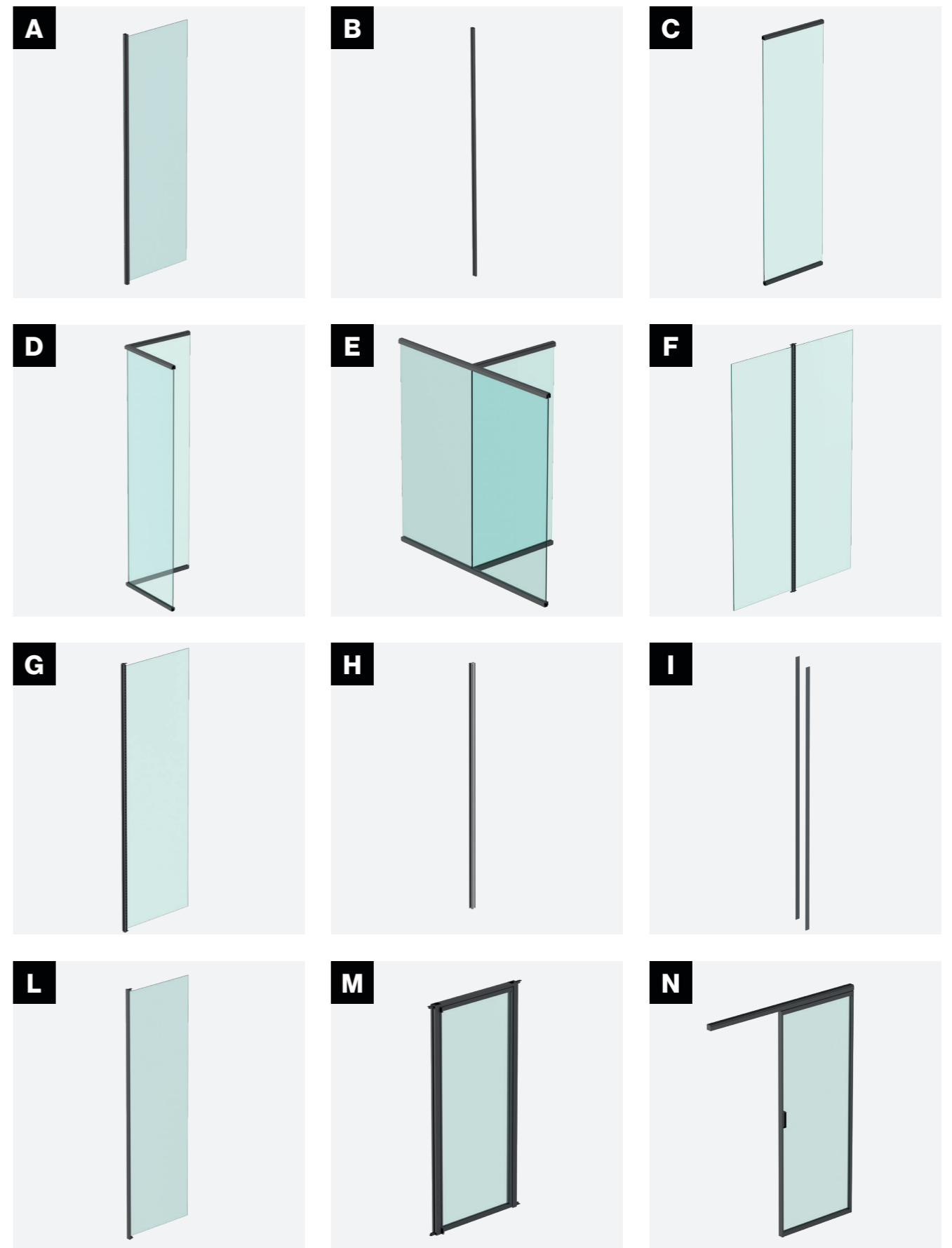

Based on the cuts of the fixed modules and depending on the standard solutions (875 mm centreline module 900 mm) it is possible to plan to have standard modules on offer inserted or to create them ad hoc.

Construction Examples

The **new equippable profiles** allow new construction solutions to be created. Below are the main examples.

#1

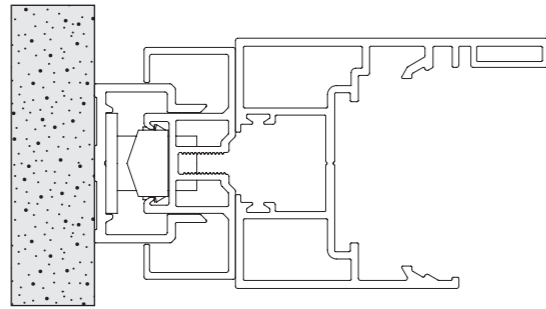

B Equippable Wall Starting Kit + **M** Pivot Door

#2

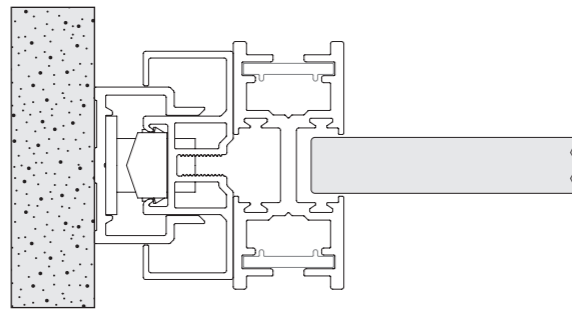

B Equippable Wall Starting Kit + **G** Equippable Rack Pole

#3

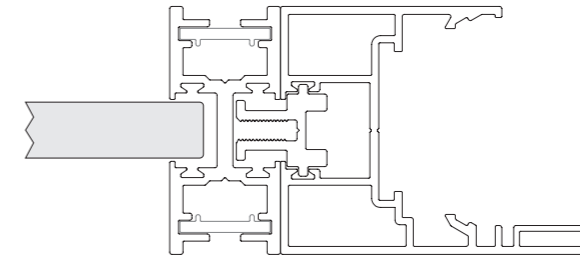

G Equippable Rack Pole + **H** Equippable Junction Pole + **M** Pivot Door

#4

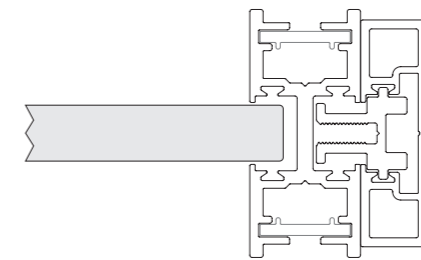

G Equippable Rack Pole + **H** Equippable Junction Pole + **L** Terminal Pole

Description of Measures

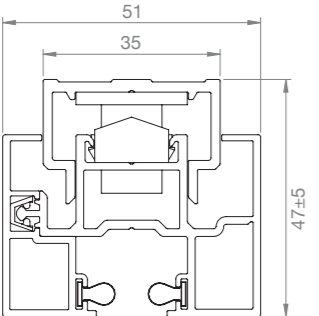
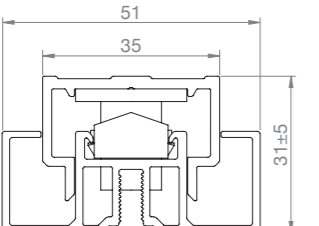
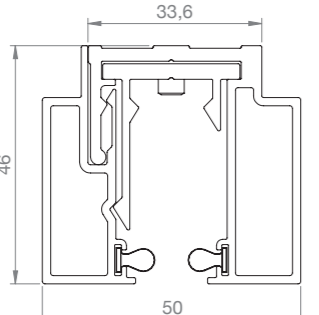
A	<p>Wall Starting Kit</p> 
B	<p>Equippable Wall Starting Kit</p> 
C	<p>Fixed Module</p> 

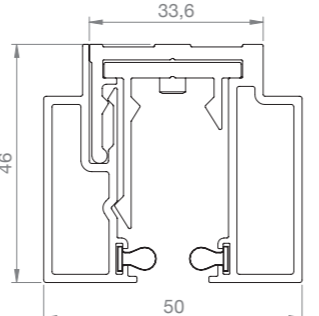
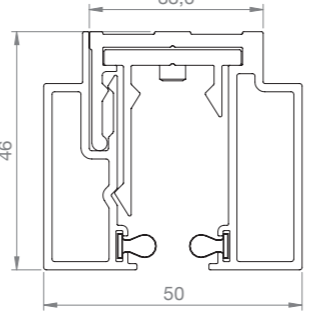
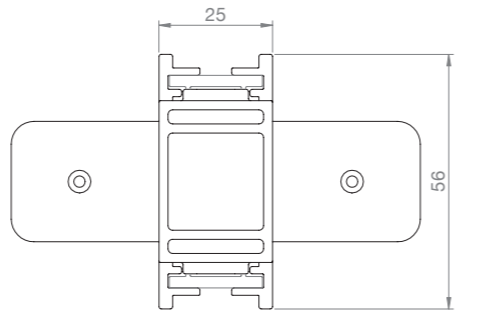
D	<p>L-Shaped Module</p> 
E	<p>T-Shaped Module</p> 
F	<p>Rack Pole</p> 



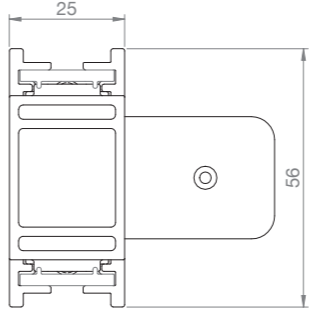
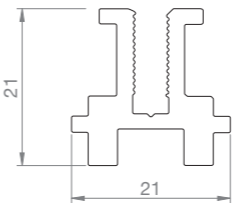
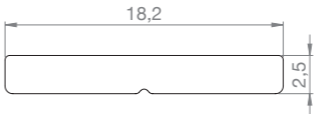
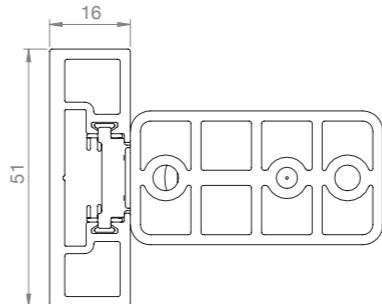

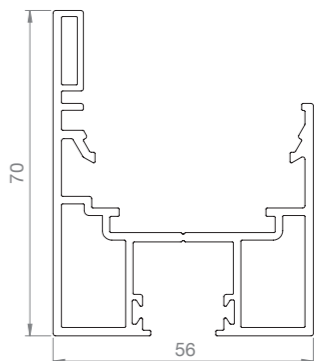
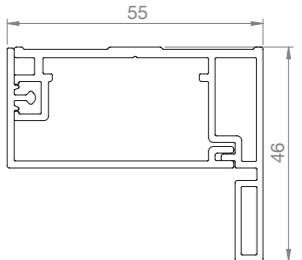
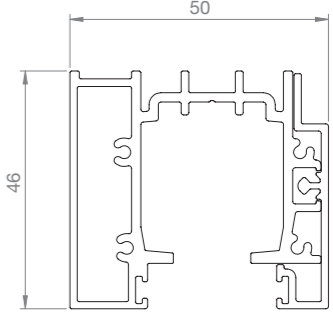



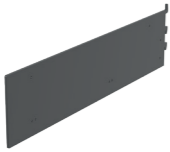

Description of Measures

G	<p>Equippable Rack Pole</p> 
H	<p>Equippable Junction Pole</p> 
I	<p>Rack Pole Covers</p> 
L	<p>Terminal Pole</p> 

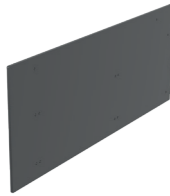
M	<p>Pivot Door</p>  <p style="text-align: center;">PILLAR</p>  <p style="text-align: center;">BEAM</p>
N	<p>Universal Door</p> 

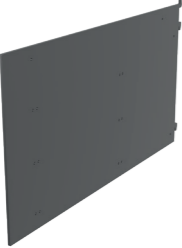
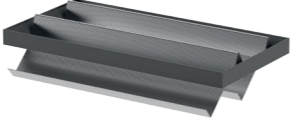
Accessories

The GRiD System comes complete with a series of practical accessories, designed to meet all functional and design needs, including basic solutions such as: wooden shelves, glass shelves, high drawers, low drawers, hangers and shelves, designed for the most common uses. **Accessories depth: 480 mm.**

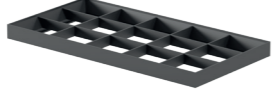
Description	Kit Code	Finishes	Description	Kit Code	Finishes
 Single bracket	K.302.09.5.0	.28 .30 .39	 Low drawer	K.301.04.5.2	.28 .30 .39
 Bracket No. 1 accessory	K.302.10.5.0	.28 .30 .39	 High drawer	K.301.05.5.2	.28 .30 .39
 Bracket No. 2 accessories	K.302.11.5.0	.28 .30 .39	 Trousers hanger	K.301.06.5.2	.28 .30 .39
 Bracket No. 3 accessories	K.302.12.5.0	.28 .30 .39	 Shoe rack	K.301.08.5.2	.28 .30 .39
 Structure for glass shelf	K.302.02.5.2	.28 .30 .39	 Clothes hanger	B.302.14.0.0	.28 .30 .39
 Small parts for wooden shelf	K.302.13.0.0.00	—	 Tie-holder	K.301.15.5.2	.28 .30 .39

FINISHES: .28 | METAL GREY - .30 | GRAPHITE - .39 | WHITE RAL 9002

GRiD accessories: possible realisations

In the table below, you will find examples of possible solutions realised with GRiD System accessories, and their order codes.

Please note: wooden and glass shelves are not supplied.

Realisation example	Components used	Order Codes	Finishes
	N°2 Single bracket + Structure for glass shelf	2x K.302.09.5.0 <input type="checkbox"/> 1x K.302.02.5.2 <input type="checkbox"/>	.28 .30 .39 .28 .30 .39
	N°2 Single bracket + Small parts for wooden shelf	2x K.302.09.5.0 <input type="checkbox"/> 1x K.302.13.0.0.00	.28 .30 .39
	N°2 Bracket No. 1 accessory + Structure for glass shelf + Low drawer	2x K.302.10.5.0 <input type="checkbox"/> 1x K.302.02.5.2 <input type="checkbox"/> 1x K.301.04.5.2 <input type="checkbox"/>	.28 .30 .39 .28 .30 .39 .28 .30 .39
	N°2 Bracket No. 1 accessory + Small parts for wooden shelf + Low drawer	2x K.302.10.5.0 <input type="checkbox"/> 1x K.302.13.0.0.00 1x K.301.04.5.2 <input type="checkbox"/>	.28 .30 .39 .28 .30 .39 .28 .30 .39
	N°2 Bracket No. 2 accessories + Structure for glass shelf + N° 2 Low drawer	2x K.302.11.5.0 <input type="checkbox"/> 1x K.302.02.5.2 <input type="checkbox"/> 2x K.301.04.5.2 <input type="checkbox"/>	.28 .30 .39 .28 .30 .39 .28 .30 .39

FINISHES: .28 | METAL GREY - .30 | GRAPHITE - .39 | WHITE RAL 9002

BASIC ACCESSORIES

POSSIBLE REALISATIONS

GRiD accessories: possible realisations

In the table below, you will find examples of possible solutions realised with GRiD System accessories, and their order codes.

Please note: wooden and glass shelves are not supplied.





Realisation example	Components used	Order Codes	Finishes
	N°2 Bracket No. 2 accessories + Structure for glass shelf + N° 1 High drawer	2 x K.302.11.5.0 1 x K.302.02.5.2 1 x K.301.05.5.2	.28 .30 .39 .28 .30 .39 .28 .30 .39
	N°2 Bracket No. 2 accessories + Small parts for wooden shelf + N° 1 High drawer	2 x K.302.11.5.0 1 x K.302.13.0.0.00 1 x K.301.05.5.2	.28 .30 .39 .28 .30 .39 .28 .30 .39
	N°2 Bracket No. 2 accessories + Small parts for wooden shelf + N° 2 Low drawer	2 x K.302.11.5.0 1 x K.302.13.0.0.00 2 x K.301.04.5.2	.28 .30 .39 .28 .30 .39 .28 .30 .39
	N°2 Bracket No. 3 accessories + Structure for glass shelf + N° 3 Low drawer	2 x K.302.12.5.0 1 x K.302.02.5.2 3 x K.301.04.5.2	.28 .30 .39 .28 .30 .39 .28 .30 .39
	N°2 Bracket No. 3 accessories + Small parts for wooden shelf + N° 3 Low drawer	2 x K.302.12.5.0 1 x K.302.13.0.0.00 3 x K.301.04.5.2	.28 .30 .39 .28 .30 .39 .28 .30 .39

FINISHES: .28 | METAL GREY - .30 | GRAPHITE - .39 | WHITE RAL 9002

GRiD accessories: possible realisations

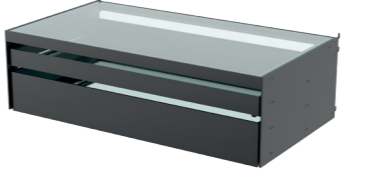
In the table below, you will find examples of possible solutions realised with GRiD System accessories, and their order codes.

Please note: wooden and glass shelves are not supplied.

Realisation example	Components used	Order Codes	Finishes
	N°2 Bracket No. 3 accessories + Structure for glass shelf + N° 1 Low drawer + N°1 High drawer	2 x K.302.12.5.0 1 x K.302.02.5.2 1 x K.301.04.5.2 1 x K.301.05.5.2	.28 .30 .39 .28 .30 .39 .28 .30 .39 .28 .30 .39
	N°2 Bracket No. 3 accessories + Small parts for wooden shelf + N° 1 Low drawer + N°1 High drawer	2 x K.302.12.5.0 1 x K.302.13.0.0.00 1 x K.301.04.5.2 1 x K.301.05.5.2	.28 .30 .39 .28 .30 .39 .28 .30 .39 .28 .30 .39
	N°2 Bracket No. 1 accessory + Small parts for wooden shelf + N° 1 Trousers hanger	2 x K.302.10.5.0 1 x K.302.13.0.0.00 1 x K.301.06.5.2	.28 .30 .39 .28 .30 .39 .28 .30 .39
	N°2 Bracket No. 1 accessory + Structure for glass shelf + N° 1 Trousers hanger	2 x K.302.10.5.0 1 x K.302.02.5.2 1 x K.301.06.5.2	.28 .30 .39 .28 .30 .39 .28 .30 .39
	N°2 Bracket No. 1 accessory + Small parts for wooden shelf + N° 1 Tie-holder	2 x K.302.10.5.0 1 x K.302.13.0.0.00 1 x K.301.15.5.2	.28 .30 .39 .28 .30 .39 .28 .30 .39

FINISHES: .28 | METAL GREY - .30 | GRAPHITE - .39 | WHITE RAL 9002



POSSIBLE REALISATIONS

POSSIBLE REALISATIONS

GRiD accessories: possible realisations

In the table below, you will find examples of possible solutions realised with GRiD System accessories, and their order codes.

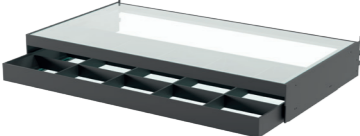
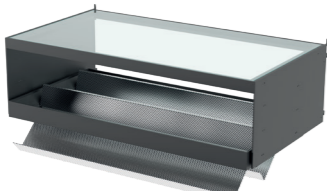
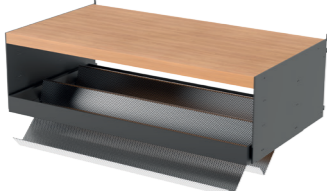

Please note: wooden and glass shelves are not supplied.

POSSIBLE REALISATIONS	Realisation example	Components used	Order Codes	Finishes	
		N°2 Bracket No. 1 accessory + Structure for glass shelf + N° 1 Tie-holder	2 x K.302.10.5.0 1 x K.302.02.5.2 1 x K.301.15.5.2	<input type="checkbox"/> <input type="checkbox"/> <input type="checkbox"/>	.28 .30 .39
		N°2 Bracket No. 3 accessories + Structure for glass shelf + N° 1 Shoe rack	2 x K.302.12.5.0 1 x K.302.02.5.2 1 x K.301.08.5.2	<input type="checkbox"/> <input type="checkbox"/> <input type="checkbox"/>	.28 .30 .39
		N°2 Bracket No. 3 accessories + Small parts for wooden shelf + N° 1 Shoe rack	2 x K.302.12.5.0 1 x K.302.13.0.0.00 1 x K.301.08.5.2	<input type="checkbox"/> <input type="checkbox"/> <input type="checkbox"/>	.28 .30 .39
		N°2 Single bracket + Small parts for wooden shelf + N°1 Clothes hanger	2 x K.302.09.5.0 1 x K.302.13.0.0.00 1 x B.302.14.0.0	<input type="checkbox"/> <input type="checkbox"/> <input type="checkbox"/>	.28 .30 .39

FINISHES: .28 | METAL GREY - .30 | GRAPHITE - .39 | WHITE RAL 9002

Universal System: handles

The table below sets out the order codes and the relevant finishes for the standard Universal System handles.

HANDLES	Description	Order Codes	Finishes	
		Pair of solid handles in Zamak	C.0420.A.1.28	Metal Grey
			C.0420.A.1.30	Graphite
			C.0420.A.1.39	White RAL 9002
		Pair of Hollow Handle in Zamak	C.0420.A.2.28	Metal Grey
			C.0420.A.2.30	Graphite
C.0420.A.2.39			White RAL 9002	

Pivot Door: covers and finishes

The table below sets out the order codes and the relevant finishes for the cover elements of the Pivot Door, which can be used in the GRiD System. **Note: Handle, latch and lock are not included in the kit.**

PIVOT DOOR SHELLS	Description	Order Codes	Finishes	
		Lock cover with Patent Key	C.0490.01.02.28	Metal Grey
			C.0490.01.02.30	Graphite
			C.0490.01.02.39	White RAL 9002
		Handle Cover with Magnetic Stricker	C.0490.01.01.28	Metal Grey
			C.0490.01.01.30	Graphite
			C.0490.01.01.39	White RAL 9002
		Cover with Euro profile cylinder hole	C.0490.01.03.28	Metal Grey
			C.0490.01.03.30	Graphite
C.0490.01.03.39			White RAL 9002	

Terms of Sale

CONDITIONS OF SALE / WARRANTY

All sales of Terno Scorrevoli products to buyers are governed by the present General Conditions (which shall be forwarded for signature at the time of reception of the first order, together with the documentation relative to confidentiality) and the Buyer must return a copy of the same to Terno Scorrevoli, duly signed for approval by a legal representative in the apposite spaces.

- 1) Terno Scorrevoli shall accept the order by sending the Buyer an order confirmation: in this way, the sales contract shall be complete and the relative order shall become effective.
- 2) The prices of the items sold shall be those shown in the Terno Scorrevoli Price List in force at the time of the order. Unless the parties agree otherwise in writing. The presence of unsolved will involve the block some orders current that will be evaded after receiving the payment of such slopes.
- 3) Consignment shall be ex our factory: the products shall therefore be consigned at the premises of Terno Scorrevoli to the respective shippers or directly to the Buyer, and the same shall be responsible for the shipping costs and transport risks.
- 4) Terno Scorrevoli products sold to resellers are guaranteed against eventual defects and/or malfunctions for a period of 12 months from the date of consignment. Directly observable defects must be reported to Terno Scorrevoli within 8 days of the date of consignment and non-observable defects must be reported within 2 months of their discovery. Finished products may be defective up to 2%, unless otherwise agreed upon between the parties in writing. Returns shall only be accepted if previously authorized by Terno Scorrevoli and only at its premises.
- 5) The present Conditions of Sale are regulated by Italian law. Any and all disputes or controversy related to the interpretation, execution or resolution of the present sales contract shall come under the exclusive jurisdiction of the Tribunal of Monza.
- 6) Terno Scorrevoli reserves the right to modify any of its articles in order to carry out an improvement.
- 7) Terno Scorrevoli will be not liable for malfunctioning or damages caused by the improper use of Terno Scorrevoli's products. The use of Terno Scorrevoli SpA products in combination with components from other manufacturers is considered improper use of the products sold.
- 8) Minimum order amount for Italian customers is net 250.00 Euros – For smaller orders, the handling fees are net 20.00 Euros.
For EU customers minimum order amount is net 500.00 Euros.
For extra EU customers minimum order amount is net 1000.00 Euros

CONDIZIONI DI VENDITA / GARANZIA

Tutte le vendite dei prodotti della Terno Scorrevoli al Compratore sono disciplinate dalle presenti Condizioni Generali (le quali gli verranno inviate per la firma, al momento dell'emissione del primo ordine, unitamente alla documentazione relativa alla privacy) e pertanto il Compratore dovrà restituire, alla Terno Scorrevoli, una copia di tali Condizioni Generali debitamente sottoscritta dal proprio legale rappresentante negli appositi spazi in calce.

- 1) La Terno Scorrevoli accetterà l'ordine inviando al Compratore la conferma d'ordine: in tal modo, si perfezionerà il contratto di vendita e il relativo ordine diverrà esecutivo.
- 2) I prezzi dei prodotti venduti saranno quelli desumibili dal listino della Terno Scorrevoli vigente al momento dell'ordine. Salvo che le parti concordino diversamente per iscritto, le scadenze delle ricevute bancarie al 31/8 e al 31/12 di ogni anno saranno posticipate rispettivamente al 10/9 e al 10/1, fermo restando tutte le altre scadenze concordate dalle parti. In caso di ritardato pagamento, alla Terno Scorrevoli spetteranno automaticamente gli interessi moratori previsti dal D. LGS. 9/11/12 n. 192 a partire dalla data di scadenza. La presenza di insoluti comporterà il blocco degli ordini in corso che saranno evasi dopo aver ricevuto il pagamento di tali pendenze, dopo che saranno acquistate le materie prime e dopo il loro relativo approntamento.
- 3) La consegna avverrà franco nostra fabbrica: pertanto, la consegna dei prodotti si intenderà perfezionata al momento della rimessione della merce agli spedizionieri o direttamente al Compratore presso la sede della Terno Scorrevoli, mentre le spese e i rischi dell'eventuale trasporto saranno a carico del Compratore stesso.
- 4) La garanzia per gli eventuali vizi o difetti dei prodotti oggetto di vendita diretta ai clienti non consumatori avrà la durata di 12 mesi a partire dalla data di consegna. Il termine per la denuncia dei vizi alla Terno Scorrevoli è di 8 giorni decorrente, quanto ai vizi apparenti, dalla data di consegna e, quanto ai vizi occulti, dalla data della loro scoperta. Sul prodotto finito è ammessa una difettosità del 2%,

- salvo diverso accordo scritto tra le parti. Non si accettano ritorni di merce se non dietro autorizzazione della Terno Scorrevoli e franco suo stabilimento.
- 5) Il presente rapporto è disciplinato dalla legge italiana. Per qualsiasi controversia relativa all'interpretazione, validità, esecuzione o risoluzione del presente rapporto di vendita sarà esclusivamente competente il Tribunale di Monza.
 - 6) La Terno Scorrevoli si riserva di liberamente modificare qualunque tipo di articolo a catalogo al fine di migliorarlo e pertanto il Compratore è tenuto, sotto la sua responsabilità, a verificare le esatte caratteristiche tecniche dei prodotti che intende acquistare prima dell'emissione del relativo ordine.
 - 7) La Terno Scorrevoli non si ritiene responsabile in caso di malfunzionamento o danni causati dall'utilizzo improprio o dalla manomissione dei propri prodotti. L'utilizzo dei prodotti Terno Scorrevoli in abbinamento con componenti di altri produttori viene considerato utilizzo improprio dei prodotti venduti.
 - 8) Minimo fatturabile per i clienti residenti nella Nazione Italia €. 250,00 Netto – Per ordini inferiori le spese di gestione sono pari ad €. 20,00 Netto. Riduzione del pagamento a Riba a 30 gg DF FM.
Per le Nazioni UE €. 500,00 Netto.
Per le Nazioni extra UE €. 1000,00 Netto.

CONDITIONS DE VENTE / GARANTIE

Toutes les ventes des produits de Terno Scorrevoli à l'acheteur sont régies par les présentes Conditions Générales (lesquelles lui seront envoyées pour signature au moment de la première commande, en même temps que la documentation concernant la confidentialité) et par conséquent l'acheteur devra renvoyer à Terno Scorrevoli un exemplaire de ces Conditions Générales dûment signé par son représentant légal dans les espaces prévus à cet effet à la fin de ce document.

- 1) La société Terno Scorrevoli acceptera la commande en envoyant la confirmation de commande à l'acheteur: le contrat de vente sera conclu de cette manière et la commande correspondante deviendra exécutoire.
- 2) Les prix des produits vendus seront ceux de la liste de prix de Terno Scorrevoli en vigueur au moment de la commande. Sauf diversement convenu entre les parties par écrit. La présence de la volonté inexplicquée implique le bloc qu'une partie commande le courant qui sera évité après avoir reçu le paiement des pentes telles.
- 3) La livraison sera franco notre usine: par conséquent, les produits seront remis, au siège de Terno Scorrevoli, aux expéditeurs correspondants ou directement à l'acheteur, alors que les frais et les risques du transport seront à la charge de l'acheteur.
- 4) La garantie pour d'éventuels vices ou défauts des produits faisant l'objet d'une vente directe aux clients non consommateurs aura une durée de 12 mois à compter de la date de livraison. Le délai pour la dénonciation de vices à Terno Scorrevoli est de 8 jours courant, pour les vices apparents, à partir de la date de livraison et pour les vices cachés à compter de la date de leur constatation. Il est admis un pourcentage de 2 % de défaut sur les produits finis, sauf accord écrit entre les parties. Aucun retour de marchandise ne sera accepté sans autorisation de Terno Scorrevoli et ils seront effectués franco ses établissements.
- 5) Le présent rapport est régi par la loi italienne. Pour tout litige concernant l'interprétation, la validité, l'exécution ou la résolution de ce rapport de vente le Tribunal de Monza sera exclusivement compétent.
- 6) Terno Scorrevoli se réserve la faculté de modifier tout type d'article dans le but de son amélioration.
- 7) La société Terno Scorrevoli n'est pas responsable d'un mauvais fonctionnement ou d'éventuels dommages causés par l'usage improprie des articles Terno Scorrevoli. L'utilisation des produits Terno Scorrevoli SpA en combinaison avec composants d'autres fabricantes est considéré comme une utilisation inappropriée des produits vendus.
- 8) Minimum factorable pour les client Italien: 250 € nets – Pour des commandes inférieures, les frais de gestion s'élevont à 20 € nets. Minimum factorable pour les client EU: 500 € nets.
Minimum factorable pour les client extra EU: 1000 € nets.

ALLGEMEINE VERKAUFSBEDINGUNGEN / GARANTIE

Diese Verkaufsbedingungen gelten als eine rechtswirksame Vereinbarung zwischen dem Käufer und Terno Scorrevoli (diese Verkaufsbedingungen werden dem Käufer zur Unterschreibung bei Ausgabe des ersten Auftrags weitergereicht, zusammen mit der Dokumentation über die Mitteilung zum Datenschutz). Sie, als Käufer, sollen eine von Ihrem bevollmächtigen Vertreter unterschriebene Kopie dieser allgemeinen Verkaufsbedingungen Terno Scorrevoli zurückgeben.

- 1) Terno Scorrevoli wird dem Käufer eine Auftragsbestätigung überreichen, die den Verkaufsvertrag abschließt und durch die den Auftrag ausführend verbindlich wird.
- 2) Die Preise der Produkte sind die, bei Auftragsendung geltenden, in der Preisliste von Terno Scorrevoli angeführten Preise. Die Gegenwart ungelöst schließt ein der Block bestellt ein bisschen Strom, der nach dem Erhalten der Zahlung von solchen Neigungen umgangen wird.
- 3) Warenlieferung erfolgt ab Werk. Die Produkte werden von Terno Scorrevoli den jeweils zuständigen Speditionsfirmen oder direkt dem Käufer geliefert. Frachtkosten und das Transportrisiko sind zu Lasten des Käufers.
- 4) Die Dauer der Garantie gegen Fehler und Mangel der zu den nicht Endverbraucher Kunden verkauften Produkte wird 12 Monate vom Lieferungsdatum sein. Beschwerde gegen Fehler und Mangel sollen Terno Scorrevoli innerhalb von 8 Tagen vom Lieferungsdatum spezifisch für sichtbare Fehler und vom Entdeckungsdatum für verborgene Fehler mitgeteilt werden. Eine Fehlertoleranz von 2% ist auf dem Endprodukt angenommen, wenn vertraglich schriftlich von den Parteien nicht anders vereinbart wurde. Warenrückgabe ist nur erstattet nach vorheriger erhaltener Zustimmung von Terno Scorrevoli. In diesem Fall sind die Frachtkosten für die Rückgabe zu Lasten des Käufers.
- 5) Dieser Vertrag unterliegt italienischem Recht. Für jede Rechtsfrage über die Interpretation, Gültigkeit, Ausführung und Auflösung des Vertrages ist ausschließlich das Gericht von Monza zuständig.
- 6) Terno Scorrevoli behält sich das Recht vor, jedes Produkt zu ändern, um Verbesserung zu verfolgen.
- 7) Das Unternehmen Terno Scorrevoli haftet auf keinen Fall bei Funktionsstörungen oder Schäden, die während eines unsachgemäßen Transportes der Terno Scorrevoli Produkte, verursacht wurden. Die Verwendung von Produkten von Terno Scorrevoli SpA in Kombination mit Komponenten anderer Hersteller gilt als nicht bestimmungsgemäße Verwendung der verkauften Produkte.
- 8) Geringster Rechnungsbetrag für Italien Kunden €. 250,00 Netto – Bei geringeren Bestellungen werden Verwaltungskosten von €. 20,00 Netto verrechnet. Geringster Rechnungsbetrag für EU Kunden €. 500,00 Netto.
Geringster Rechnungsbetrag für extra EU Kunden €. 1000,00 Netto.

CONDICIONES GENERALES DE VENTA / GARANTÍA

Todas las ventas de los productos de Terno Scorrevoli al Comprador están reguladas por las presentes Condiciones Generales (las cuales se enviarán para ser firmadas en el momento de la emisión del primer pedido, junto a la documentación relativa a la privacidad) y por tanto el Comprador tendrá que

DEADLINES

Unaccepted trade bills due date of 31/08 and 31/12 deferred to 10/09 and 10/01, all other maturity dates remain unchanged.
We issue confirmations for orders and thus are not liable for any mistakes in quantities, prices, articles, holes, measurements, etc.

Al 31/8 e al 31/12 posticipo al 10/09 e al 10/01 successivo fermo restando le altre scadenze a tutti gli ordini segue nostra conferma d'ordine,
Pertanto ci solleviamo da eventuali vostri reclami per errate quantità, prezzi, articoli, forature, misure, etc.

TERNO SCORREVOLI has the right of modifying and improving any of its articles.

TERNO SCORREVOLI si riserva di poter modificare qualunque tipo di articolo al fine di ottenere un miglioramento.

TERNO SCORREVOLI se réserve le droit d'apporter des modifications à n'importe quel article susceptibles d'entraîner une amélioration.

TERNO SCORREVOLI behält sich das Recht vor, jeden Artikel für Verbesserungen verändern zu können.

TERNO SCORREVOLI se reserva el derecho de modificar cualquier artículo con el fin de mejorarlo.

devolver a Terno Scorrevoli, una copia de dichas Condiciones Generales debidamente firmada por su representante legal en los correspondientes espacios a pie de página.

- 1) Terno Scorrevoli aceptará el pedido enviando al Comprador la confirmación del mismo: de esta forma se perfeccionará el contrato de venta y el relativo pedido será ejecutivo.
- 2) Los precios de los productos vendidos serán los presentados en el listín de precios de Terno Scorrevoli vigente en el momento del pedido. Excepto en el caso de que las partes tomen un acuerdo diferente por escrito. La presencia de voluntad sin resolver implica el bloque que una parte pide corriente que se eludirá después de recibir el pago de inclinaciones tales.
- 3) La entrega se realizará franco nuestra fábrica: es decir, los productos se entregarán en la sede de Terno Scorrevoli a los respectivos transportistas o directamente al Comprador, por tanto los gastos y los riesgos del transporte serán a cargo del Comprador.
- 4) La garantía por eventuales fallos o defectos de los productos objeto de la venta directa a los clientes no consumidores tendrá una duración de 12 meses a partir de la fecha de entrega. El plazo para denunciar los fallos a Terno Scorrevoli, por lo que se refiere a los fallos aparentes, es de 8 a partir de la fecha de entrega y, respecto a los fallos ocultos, a partir de la fecha de su descubrimiento. Respecto al producto acabado se admite un porcentaje de defecto del 2%, excepto un diferente acuerdo escrito entre las partes. No se aceptan devoluciones de mercancías sin la previa autorización de Terno Scorrevoli y franco fábrica del Cliente.
- 5) La presente relación está regulada por la ley italiana. Para cualquier controversia relativa a la interpretación, validez, ejecución o resolución de la presente relación de venta será competente exclusivamente el Tribunal de Monza.
- 6) Terno Scorrevoli se reserva el derecho de poder modificar cualquier tipo de artículo con el fin de obtener una mejora.
- 7) La Terno Scorrevoli no se responsabiliza en caso de mal funcionamiento o daños causados por el uso impropio de los productos Terno Scorrevoli. El uso de los productos Terno Scorrevoli SpA en combinación con componentes de otros fabricantes se considera uso inadecuado de los productos vendidos.
- 8) Mínimo facturable para clientes italianos €. 250,00 netos – Para pedidos de menor valor los gastos de gestión son de € 20,00 netos.
Mínimo facturable para clientes EU €. 500,00 netos.
Mínimo facturable para clientes extra EU €. 1000,00 netos.

grid.ternoscorrevoli.com

www.ternoscorrevoli.com

Terno Scorrevoli S.p.A.

Via Ravenna, 4 - 20814 Varedo (MB) ITALY
Phone +39 0362 543001

terno@ternoscorrevoli.com